

---

# **RTM-ATCA-747x-10G**

Control via IPMI Programmer's Reference

P/N: 6806800S81C

November 2019

---



**SMART**<sup>™</sup>  
Embedded Computing

© 2019 SMART Embedded Computing™, Inc.

All Rights Reserved.

## Trademarks

The stylized "S" and "SMART" is a registered trademark of SMART Modular Technologies, Inc. and "SMART Embedded Computing" and the SMART Embedded Computing logo are trademarks of SMART Modular Technologies, Inc. All other names and logos referred to are trade names, trademarks, or registered trademarks of their respective owners. These materials are provided by SMART Embedded Computing as a service to its customers and may be used for informational purposes only.

## Disclaimer\*

SMART Embedded Computing (SMART EC) assumes no responsibility for errors or omissions in these materials. **These materials are provided "AS IS" without warranty of any kind, either expressed or implied, including but not limited to, the implied warranties of merchantability, fitness for a particular purpose, or non-infringement.** SMART EC further does not warrant the accuracy or completeness of the information, text, graphics, links or other items contained within these materials. SMART EC shall not be liable for any special, indirect, incidental, or consequential damages, including without limitation, lost revenues or lost profits, which may result from the use of these materials. SMART EC may make changes to these materials, or to the products described therein, at any time without notice. SMART EC makes no commitment to update the information contained within these materials.

Electronic versions of this material may be read online, downloaded for personal use, or referenced in another document as a URL to a SMART EC website. The text itself may not be published commercially in print or electronic form, edited, translated, or otherwise altered without the permission of SMART EC.

It is possible that this publication may contain reference to or information about SMART EC products, programming, or services that are not available in your country. Such references or information must not be construed to mean that SMART EC intends to announce such SMART EC products, programming, or services in your country.

## Limited and Restricted Rights Legend

If the documentation contained herein is supplied, directly or indirectly, to the U.S. Government, the following notice shall apply unless otherwise agreed to in writing by SMART Embedded Computing.

Use, duplication, or disclosure by the Government is subject to restrictions as set forth in subparagraph (b)(3) of the Rights in Technical Data clause at DFARS 252.227-7013 (Nov. 1995) and of the Rights in Noncommercial Computer Software and Documentation clause at DFARS 252.227-7014 (Jun. 1995).

**SMART Embedded Computing, Inc.**

2900 S. Diablo Way, Suite 190

Tempe, Arizona 85282

USA

\*For full legal terms and conditions, visit [www.smartembedded.com/ec/legal](http://www.smartembedded.com/ec/legal)

# Table of Contents

---

- About this Manual** ..... 9
  
- 1 Introduction** ..... 13
  - 1.1 Overview ..... 13
  
- 2 Supported IPMI Commands** ..... 15
  - 2.1 Overview ..... 15
  - 2.2 Standard IPMI Commands ..... 15
    - 2.2.1 Global IPMI Commands ..... 15
    - 2.2.2 System Interface Commands ..... 15
  
- 3 FRU Information and Sensor Data Records** ..... 17
  - 3.1 FRU Information ..... 17
  - 3.2 Sensor Data Records ..... 17
  
- A Related Documentation** ..... 35
  - A.1 SMART Embedded Computing Documentation ..... 35

## Table of Contents

---

# List of Figures

---

Figure 3-1	Location of Temperature Sensors of RTM-ATCA-747x-10G-D (Variant #1) . . . . .	18
Figure 3-2	Location of Temperature Sensors of RTM-ATCA-747x-10G-SP (Variant #2) . . . . .	18

## List of Figures

---

# List of Tables

---

Table 2-1	Supported Global IPMI Commands .....	15
Table 2-2	System Interface Commands .....	15
Table 3-1	FRU Information .....	17
Table 3-2	IPMI Sensors Overview .....	17
Table 3-3	RTM Hot Swap Sensor .....	19
Table 3-4	RTM 12V Sensor .....	20
Table 3-5	RTM 3.3V Sensor .....	21
Table 3-6	RTM 1.2V Sensor .....	22
Table 3-7	RTM 1.0V Sensor .....	23
Table 3-8	Air Inlet Temp Sensor .....	24
Table 3-9	Air Outlet Temp Sensor .....	25
Table 3-10	Temp 1G ETH Sensor .....	26
Table 3-11	Temp 1-10G ETH Sensor .....	27
Table 3-12	Temp2-10G ETH Sensor .....	28
Table 3-13	Temp 3-10G ETH Sensor .....	29
Table 3-14	Temp SAS Sensor .....	30
Table 3-15	Temp PCI Switch Sensor .....	31
Table 3-16	Hot Swap HDD Sensor .....	32
Table 3-17	RTM Watchdog Sensor .....	33
Table A-1	SMART EC Documentation .....	35

## List of Tables

---



# About this Manual

---

## Overview of Contents

This manual is intended for users qualified in electronics or electrical engineering. Users must have a working understanding of Intelligent Platform Management Interface (IPMI).

It provides information on how to control and monitor the functionality of the ATCA-7470/ATCA-7475 via IPMI and contains the following chapters and appendices:

*Chapter 1, Introduction on page 13*

*Chapter 2, Supported IPMI Commands on page 15*

*Chapter 3, FRU Information and Sensor Data Records on page 17*

*Appendix A, Related Documentation on page 35*



## Abbreviations





This document uses the following abbreviations:

<b>Abbreviation</b>	<b>Definition</b>
AdvancedTCA	Advanced Telecommunications Computing Architecture
ARTM	AdvancedTCA Rear Transition Module
ATA	Advanced Technology Attachment
FRU	Field Replaceable Unit
IPMC	Intelligent Platform Management Controller
IPMI	Intelligent Platform Management Interface
SDR	Sensor Data Record
SEL	System Event Log

# Conventions

The following table describes the conventions used throughout this manual..

Notation	Description
0x00000000	Typical notation for hexadecimal numbers (digits are 0 through F), for example used for addresses and offsets
0b0000	Same for binary numbers (digits are 0 and 1)
<b>bold</b>	Used to emphasize a word
Screen	Used for on-screen output and code related elements or commands. Sample of Programming used in a table (9pt)
<b>Courier + Bold</b>	Used to characterize user input and to separate it from system output
<i>Reference</i>	Used for references and for table and figure descriptions
File > Exit	Notation for selecting a submenu
<text>	Notation for variables and keys
[text]	Notation for software buttons to click on the screen and parameter description
...	Repeated item for example node 1, node 2, ..., node 12
.	Omission of information from example/command that is not necessary at the time
..	Ranges, for example: 0..4 means one of the integers 0,1,2,3, and 4 (used in registers)
	Logical OR
	Indicates a hazardous situation which, if not avoided, could result in death or serious injury
	Indicates a hazardous situation which, if not avoided, may result in minor or moderate injury

Notation	Description
	Indicates a property damage message
	Indicates a hot surface that could result in moderate or serious injury
	Indicates an electrical situation that could result in moderate injury or death
<p>Use ESD protection</p> 	Indicates that when working in an ESD environment care should be taken to use proper ESD practices
	No danger encountered, pay attention to important information

## Summary of Changes

Document Number	Date	Description
6806800S81C	November 2019	Rebrand to SMART Embedded Computing template.
6806800S81B	May 2014	Re-branded to Artesyn. Updated <a href="#">Figure 3-1 on page 18</a> and <a href="#">Figure 3-2 on page 18</a> .
6806800S81A	January 2014	Initial Version



# Introduction

---

## 1.1 Overview

The RTM-ATCA-747x-10G provides an on-board Intelligent Peripheral Management Controller (IPMC) which is fully compliant to the IPMI V1.5 specification. The IPMC provides access to on-board Sensor Data Records (SDRs), Field Replaceable Unit (FRU) data and further more contains an event generator. Within this document you find a description of:

- Supported IPMI command
- FRU data
- SDRs

The following Rear Transition Module (RTM) product variants are available:

- RTM-ATCA-747x-10G-D (Variant #1)
- RTM-ATCA-747x-10G-SP (Variant #2)

RTM-ATCA-747x-10G-D features:

- Four 10Gb interfaces using SFP+ modules
- Four 10/100/1000Base-T Ethernet ports; RJ-45 connectors
- Optional hot swappable 2.5" SAS HDD (supported through on-board SAS controller)

RTM-ATCA-747x-10G-SP features:

- Six 10Gb interfaces using SFP+ modules
- Four 10/100/1000Base-T Ethernet ports; RJ-45 connectors

Both RTM-ATCA-747x-10G-D and RTM-ATCA-747x-10G-SP variants are compatible with the following Front blades:

- ATCA-7470
- ATCA-7475



# Supported IPMI Commands

## 2.1 Overview

This chapter describes the IPMI commands supported by the RTM-ATCA-747x-10G platforms.

## 2.2 Standard IPMI Commands

The IPMCs are fully compliant to the Intelligent Platform Management Interface v.1.5. This section provides information on which IPMI commands are supported.

### 2.2.1 Global IPMI Commands

The IPMCs support the following global IPMI commands.

*Table 2-1 Supported Global IPMI Commands*

Command	NetFn (Request/Response)	CMD	Comments
Get Device ID	0x06/0x07	0x01	-
Get Self Test Result	0x06/0x07	0x04	-
Warm Reset	0x06/0x07	0x03	-
Master Write-Read	0x06/0x07	0x52	Only for accessing private I <sup>2</sup> C buses.

### 2.2.2 System Interface Commands

The system interface commands are supported by blades providing a system interface.

*Table 2-2 System Interface Commands*

Command	NetFn (Request/Response)	CMD
Set BMC Global Enables	0x06/0x07	0x2E
Get BMC Global Enables	0x06/0x07	0x2F
Clear Message Flags	0x06/0x07	0x30
Get Message Flags	0x06/0x07	0x31
Get Message	0x06/0x07	0x33
Send Message	0x06/0x07	0x34

## Supported IPMI Commands

---



# FRU Information and Sensor Data Records

## 3.1 FRU Information

The blade provides the following FRU information in FRU ID 0.

*Table 3-1 FRU Information*

Variant Number	Board Information		
	Product Name	Serial Number	Part Number
1	RTM-ATCA-747X-10G-D	123456789123	0106861L06*
2	RTM-ATCA-747X-10G-SP	123456789123	0106861L07*

## 3.2 Sensor Data Records

The sensors available on the blade/RTM are shown in the table below.

*Table 3-2 IPMI Sensors Overview*

Feature	Raw Value	Detailed SDR Description
Hot Swap RTM	Switch	See <a href="#">RTM Hot Swap Sensor on page 19</a>
+12V	Voltage	See <a href="#">RTM 12V Sensor on page 20</a>
+3.3V RTM	Voltage	See <a href="#">RTM 3.3V Sensor on page 21</a>
+1.2V RTM	Voltage	See <a href="#">RTM 1.2V Sensor on page 22</a>
+1.0V RTM	Voltage	See <a href="#">RTM 1.0V Sensor on page 23</a>
air inlet temp	Temperature	See <a href="#">Air Inlet Temp Sensor on page 24</a>
air outlet temp	Temperature	See <a href="#">Air Outlet Temp Sensor on page 25</a>
temp 1G ETH	Temperature	See <a href="#">Temp 1G ETH Sensor on page 26</a>
temp 1-10G ETH	Temperature	See <a href="#">Temp 1-10G ETH Sensor on page 27</a>
temp 2-10G ETH	Temperature	See <a href="#">Temp2-10G ETH Sensor on page 28</a>
temp 3-10G ETH	Temperature	See <a href="#">Temp 3-10G ETH Sensor on page 29</a>
temp SAS	Temperature	See <a href="#">Temp SAS Sensor on page 30</a>
temp PCIe switch	Temperature	See <a href="#">Temp PCI Switch Sensor on page 31</a>
Hot Swap HDD	Switch	See <a href="#">Hot Swap HDD Sensor on page 32</a>
RTM Watchdog	Watchdog 2	See <a href="#">RTM Watchdog Sensor on page 33</a>

## FRU Information and Sensor Data Records

The following figure shows the location of all temperature sensors.

*Figure 3-1 Location of Temperature Sensors of RTM-ATCA-747x-10G-D (Variant #1)*

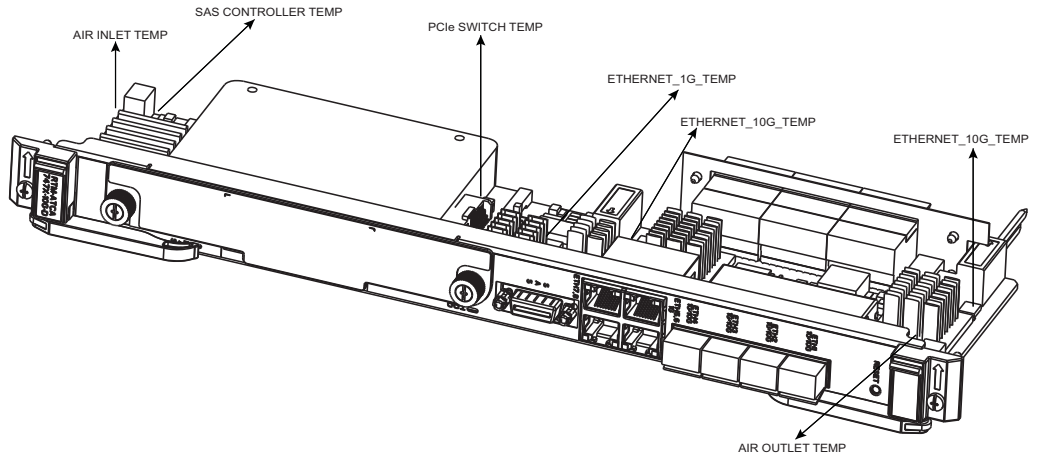

*Figure 3-2 Location of Temperature Sensors of RTM-ATCA-747x-10G-SP (Variant #2)*

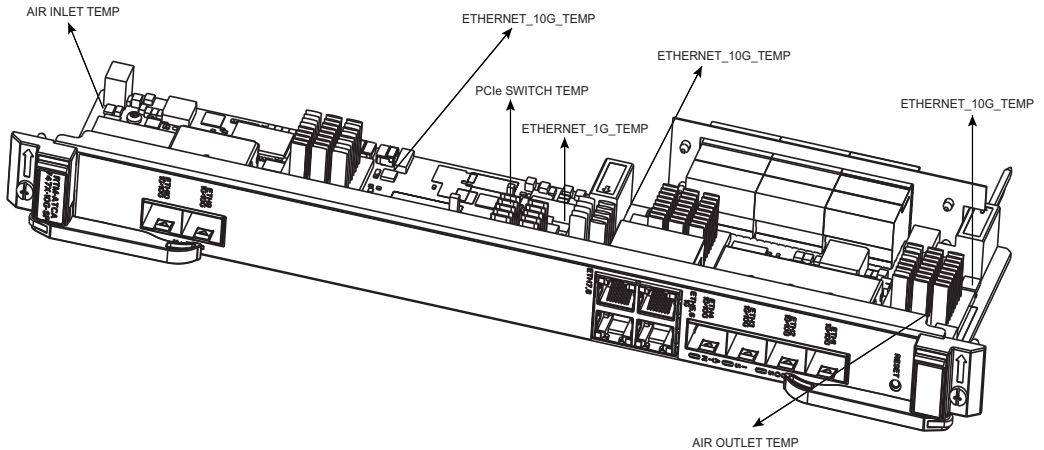

## FRU Information and Sensor Data Records

The following tables describe all on-board IPMI sensors in detail.

*Table 3-3 RTM Hot Swap Sensor*

<b>Feature</b>	<b>Raw Value</b>	<b>Description</b>
Sensor LUN	0x00	-
Sensor Number	0x00	-
Entity ID	0xC0	PICMG Rear Transition Module
Sensor Type	0xF0	PICMG 3.0: FRU Hot Swap
Event/Reading Type	0x6F	Discrete (sensor-specific)
Assertion Event Mask(Byte 15)	0x07	-
Assertion Event Mask(Byte 16)	0x00	-
Deassertion Event Mask(Byte 17)	0x00	-
Deassertion Event Mask(Byte 18)	0x00	-
Threshold Mask(Byte 19)	0x07	-
Threshold Mask(Byte 20)	0x00	-
Base Unit	0x00	(unspecified)
Sensor Name	Hot Swap RTM	-
Rearm mode	0x01	Auto
Hysteresis Support	0x00	No Hysteresis or unspecified
Threshold Access Support	0x00	No Thresholds
Event Message Control	0x01	Entire Sensor only
Reading Definition	-	Refer <i>chapter "Reading the FRU Hot-Swap Sensor" in the PICMG 3.0 Specification manual</i>

## FRU Information and Sensor Data Records

Table 3-4 RTM 12V Sensor

Features	Raw Value	Description
Sensor LUN	0x00	-
Sensor Number	0x00	-
Entity ID	0xC0	PICMG Rear Transition Module
Sensor Type	0x02	Voltage
Event/Reading Type	0x01	Threshold
Assertion Event Mask(Byte 15)	0x95	-
Assertion Event Mask(Byte 16)	0x7A	-
Deassertion Event Mask(Byte 17)	0x95	-
Deassertion Event Mask(Byte 18)	0x7A	-
Threshold Mask(Byte 19)	0x3F	-
Threshold Mask(Byte 20)	0x3F	-
Base Unit	0x04	Volts
Nominal Reading	0xDA	12.0
Upper non-recoverable threshold	0xF7	13.6
Upper critical threshold	0xF3	13.4
Upper non-critical threshold	0xEC	13.0
Lower non-recoverable threshold	0x BD	10.4
Lower critical threshold	0xC0	10.6
Lower non-critical threshold	0xC8	11.0
Sensor Name	+12V	-
Rearm mode	0x01	Auto
Hysteresis Support	0x01	Readable
Threshold Access Support	0x01	Readable
Event Message Control	0x00	Per Threshold / Discrete State
Reading Definition	Analog reading byte	Analog sensor reading

*Table 3-5 RTM 3.3V Sensor*

<b>Features</b>	<b>Raw Value</b>	<b>Description</b>
Sensor LUN	0x00	-
Sensor Number	0x00	-
Entity ID	0xC0	PICMG Rear Transition Module
Sensor Type	0x02	Voltage
Event/Reading Type	0x01	Threshold
Assertion Event Mask(Byte 15)	0x14	-
Assertion Event Mask(Byte 16)	0x6A	-
Deassertion Event Mask(Byte 17)	0x14	-
Deassertion Event Mask(Byte 18)	0x6A	-
Threshold Mask(Byte 19)	0x36	-
Threshold Mask(Byte 20)	0x36	-
Base Unit	0x04	Volts
Nominal Reading	0xA9	3.3
Upper non-recoverable threshold	0xB8	3.66
Upper critical threshold	0xB3	3.5
Lower non-recoverable threshold	0x97	2.94
Lower critical threshold	0x9F	3.1
Sensor Name	+3.3V RTM	-
Rearm mode	0x01	Auto
Hysteresis Support	0x01	Readable
Threshold Access Support	0x01	Readable
Event Message Control	0x00	Per Threshold / Discrete State
Reading Definition	Analog reading byte	Analog sensor reading

## FRU Information and Sensor Data Records

Table 3-6 RTM 1.2V Sensor

Features	Raw Value	Description
Sensor LUN	0x00	-
Sensor Number	0x00	-
Entity ID	0xC0	PICMG Rear Transition Module
Sensor Type	0x02	Voltage
Event/Reading Type	0x01	Threshold
Assertion Event Mask(Byte 15)	0x14	-
Assertion Event Mask(Byte 16)	0x6A	-
Deassertion Event Mask(Byte 17)	0x14	-
Deassertion Event Mask(Byte 18)	0x6A	-
Threshold Mask(Byte 19)	0x36	-
Threshold Mask(Byte 20)	0x36	-
Base Unit	0x04	Volts
Nominal Reading	0x7B	1.2
Upper non-recoverable threshold	0x88	1.33
Upper critical threshold	0x82	1.27
Lower non-recoverable threshold	0x6E	1.07
Lower critical threshold	0x74	1.13
Sensor Name	+1.2V RTM	-
Rearm mode	0x01	Auto
Hysteresis Support	0x01	Readable
Threshold Access Support	0x01	Readable
Event Message Control	0x00	Per Threshold / Discrete State
Reading Definition	Analog reading byte	Analog sensor reading

*Table 3-7 RTM 1.0V Sensor*

<b>Features</b>	<b>Raw Value</b>	<b>Description</b>
Sensor LUN	0x00	-
Sensor Number	0x00	-
Entity ID	0xC0	PICMG Rear Transition Module
Sensor Type	0x02	Voltage
Event/Reading Type	0x01	Threshold
Assertion Event Mask(Byte 15)	0x14	-
Assertion Event Mask(Byte 16)	0x6A	-
Deassertion Event Mask(Byte 17)	0x14	-
Deassertion Event Mask(Byte 18)	0x6A	-
Threshold Mask(Byte 19)	0x36	-
Threshold Mask(Byte 20)	0x36	-
Base Unit	0x04	Volts
Nominal Reading	0x67	1.0
Upper non-recoverable threshold	0x72	1.11
Upper critical threshold	0x6D	1.06
Lower non-recoverable threshold	0x5B	0.89
Lower critical threshold	0x60	0.94
Sensor Name	+1.0V RTM	-
Rearm mode	0x01	Auto
Hysteresis Support	0x01	Readable
Threshold Access Support	0x01	Readable
Event Message Control	0x00	Per Threshold / Discrete State
Reading Definition	Analog reading byte	Analog sensor reading

## FRU Information and Sensor Data Records

Table 3-8 Air Inlet Temp Sensor

Features	Raw Value	Description
Sensor LUN	0x00	-
Sensor Number	0x00	-
Entity ID	0xC0	PICMG Rear Transition Module
Sensor Type	0x01	Temperature
Event/Reading Type	0x01	Threshold
Assertion Event Mask(Byte 15)	0x80	-
Assertion Event Mask(Byte 16)	0x0A	-
Deassertion Event Mask(Byte 17)	0x80	-
Deassertion Event Mask(Byte 18)	0x7A	-
Threshold Mask(Byte 19)	0x38	-
Threshold Mask(Byte 20)	0x38	-
Base Unit	0x01	deg. C
Nominal Reading		25
Upper non-recoverable threshold		74
Upper critical threshold		61
Upper non-critical threshold		46
Lower non-recoverable threshold	0x 00	(unspecified)
Lower critical threshold	0x00	(unspecified)
Lower non-critical threshold	0x00	(unspecified)
Sensor Name	air inlet temp	-
Rearm mode	0x01	Auto
Hysteresis Support	0x01	Readable
Threshold Access Support	0x01	Readable
Event Message Control	0x00	Per Threshold / Discrete State
Reading Definition	Analog reading byte	Analog sensor reading



## FRU Information and Sensor Data Records

*Table 3-9 Air Outlet Temp Sensor*

<b>Feature</b>	<b>Raw Value</b>	<b>Description</b>
Sensor LUN	0x00	-
Sensor Number	0x00	-
Entity ID	0xC0	PICMG Rear Transition Module
Sensor Type	0x01	Temperature
Event/Reading Type	0x01	Threshold
Assertion Event Mask(Byte 15)	0x80	-
Assertion Event Mask(Byte 16)	0x0A	-
Deassertion Event Mask(Byte 17)	0x80	-
Deassertion Event Mask(Byte 18)	0x7A	-
Threshold Mask(Byte 19)	0x38	-
Threshold Mask(Byte 20)	0x38	-
Base Unit	0x01	deg. C
Nominal Reading		25
Upper non-recoverable threshold		74
Upper critical threshold		63
Upper non-critical threshold		50
Lower non-recoverable threshold	0x 00	(unspecified)
Lower critical threshold	0x00	(unspecified)
Lower non-critical threshold	0x00	(unspecified)
Sensor Name	air outlet temp	-
Rearm mode	0x01	Auto
Hysteresis Support	0x01	Readable
Threshold Access Support	0x01	Readable
Event Message Control	0x00	Per Threshold / Discrete State
Reading Definition	Analog reading byte	Analog sensor reading

## FRU Information and Sensor Data Records

Table 3-10 Temp 1G ETH Sensor

Feature	Raw Value	Description
Sensor LUN	0x00	-
Sensor Number	0x00	-
Entity ID	0xC0	PICMG Rear Transition Module
Sensor Type	0x01	Temperature
Event/Reading Type	0x01	Threshold
Assertion Event Mask(Byte 15)	0x80	-
Assertion Event Mask(Byte 16)	0x0A	-
Deassertion Event Mask(Byte 17)	0x80	-
Deassertion Event Mask(Byte 18)	0x7A	-
Threshold Mask(Byte 19)	0x38	-
Threshold Mask(Byte 20)	0x38	-
Base Unit	0x01	deg. C
Nominal Reading		25
Upper non-recoverable threshold		89
Upper critical threshold		82
Upper non-critical threshold		71
Lower non-recoverable threshold	0x 00	(unspecified)
Lower critical threshold	0x00	(unspecified)
Lower non-critical threshold	0x00	(unspecified)
Sensor Name	temp 1G ETH	-
Rearm mode	0x01	Auto
Hysteresis Support	0x01	Readable
Threshold Access Support	0x01	Readable
Event Message Control	0x00	Per Threshold / Discrete State
Reading Definition	Analog reading byte	Analog sensor reading

## FRU Information and Sensor Data Records

*Table 3-11 Temp 1-10G ETH Sensor*

<b>Feature</b>	<b>Raw Value</b>	<b>Description</b>
Sensor LUN	0x00	-
Sensor Number	0x00	-
Entity ID	0xC0	PICMG Rear Transition Module
Sensor Type	0x01	Temperature
Event/Reading Type	0x01	Threshold
Assertion Event Mask(Byte 15)	0x80	-
Assertion Event Mask(Byte 16)	0x0A	-
Deassertion Event Mask(Byte 17)	0x80	-
Deassertion Event Mask(Byte 18)	0x7A	-
Threshold Mask(Byte 19)	0x38	-
Threshold Mask(Byte 20)	0x38	-
Base Unit	0x01	deg. C
Nominal Reading		25
Upper non-recoverable threshold		103
Upper critical threshold		95
Upper non-critical threshold		81
Lower non-recoverable threshold	0x 00	(unspecified)
Lower critical threshold	0x00	(unspecified)
Lower non-critical threshold	0x00	(unspecified)
Sensor Name	temp 1-10G ETH	-
Rearm mode	0x01	Auto
Hysteresis Support	0x01	Readable
Threshold Access Support	0x01	Readable
Event Message Control	0x00	Per Threshold / Discrete State
Reading Definition	Analog reading byte	Analog sensor reading

## FRU Information and Sensor Data Records

Table 3-12 Temp2-10G ETH Sensor

Feature	Raw Value	Description
Sensor LUN	0x00	-
Sensor Number	0x00	-
Entity ID	0xC0	PICMG Rear Transition Module
Sensor Type	0x01	Temperature
Event/Reading Type	0x01	Threshold
Assertion Event Mask(Byte 15)	0x80	-
Assertion Event Mask(Byte 16)	0x0A	-
Deassertion Event Mask(Byte 17)	0x80	-
Deassertion Event Mask(Byte 18)	0x7A	-
Threshold Mask(Byte 19)	0x38	-
Threshold Mask(Byte 20)	0x38	-
Base Unit	0x01	deg. C
Nominal Reading		25
Upper non-recoverable threshold		96
Upper critical threshold		87
Upper non-critical threshold		75
Lower non-recoverable threshold	0x 00	(unspecified)
Lower critical threshold	0x00	(unspecified)
Lower non-critical threshold	0x00	(unspecified)
Sensor Name	temp 2-10G ETH	-
Rearm mode	0x01	Auto
Hysteresis Support	0x01	Readable
Threshold Access Support	0x01	Readable
Event Message Control	0x00	Per Threshold / Discrete State
Reading Definition	Analog reading byte	Analog sensor reading

## FRU Information and Sensor Data Records

*Table 3-13 Temp 3-10G ETH Sensor*

<b>Feature</b>	<b>Raw Value</b>	<b>Description</b>
Sensor LUN	0x00	-
Sensor Number	0x00	-
Entity ID	0xC0	PICMG Rear Transition Module
Sensor Type	0x01	Temperature
Event/Reading Type	0x01	Threshold
Assertion Event Mask(Byte 15)	0x80	-
Assertion Event Mask(Byte 16)	0x0A	-
Deassertion Event Mask(Byte 17)	0x80	-
Deassertion Event Mask(Byte 18)	0x7A	-
Threshold Mask(Byte 19)	0x38	-
Threshold Mask(Byte 20)	0x38	-
Base Unit	0x01	deg. C
Nominal Reading		25
Upper non-recoverable threshold		96
Upper critical threshold		87
Upper non-critical threshold		75
Lower non-recoverable threshold	0x 00	(unspecified)
Lower critical threshold	0x00	(unspecified)
Lower non-critical threshold	0x00	(unspecified)
Sensor Name	temp 3-10G ETH	-
Rearm mode	0x01	Auto
Hysteresis Support	0x01	Readable
Threshold Access Support	0x01	Readable
Event Message Control	0x00	Per Threshold / Discrete State
Reading Definition	Analog reading byte	Analog sensor reading

## FRU Information and Sensor Data Records

Table 3-14 Temp SAS Sensor

Feature	Raw Value	Description
Sensor LUN	0x00	-
Sensor Number	0x00	-
Entity ID	0xC0	PICMG Rear Transition Module
Sensor Type	0x01	Temperature
Event/Reading Type	0x01	Threshold
Assertion Event Mask(Byte 15)	0x80	-
Assertion Event Mask(Byte 16)	0x0A	-
Deassertion Event Mask(Byte 17)	0x80	-
Deassertion Event Mask(Byte 18)	0x7A	-
Threshold Mask(Byte 19)	0x38	-
Threshold Mask(Byte 20)	0x38	-
Base Unit	0x01	deg. C
Nominal Reading		25
Upper non-recoverable threshold		89
Upper critical threshold		82
Upper non-critical threshold		71
Lower non-recoverable threshold	0x 00	(unspecified)
Lower critical threshold	0x00	(unspecified)
Lower non-critical threshold	0x00	(unspecified)
Sensor Name	temp SAS	-
Rearm mode	0x01	Auto
Hysteresis Support	0x01	Readable
Threshold Access Support	0x01	Readable
Event Message Control	0x00	Per Threshold / Discrete State
Reading Definition	Analog reading byte	Analog sensor reading

## FRU Information and Sensor Data Records

*Table 3-15 Temp PCI Switch Sensor*

<b>Feature</b>	<b>Raw Value</b>	<b>Description</b>
Sensor LUN	0x00	-
Sensor Number	0x00	-
Entity ID	0xC0	PICMG Rear Transition Module
Sensor Type	0x01	Temperature
Event/Reading Type	0x01	Threshold
Assertion Event Mask(Byte 15)	0x80	-
Assertion Event Mask(Byte 16)	0x0A	-
Deassertion Event Mask(Byte 17)	0x80	-
Deassertion Event Mask(Byte 18)	0x7A	-
Threshold Mask(Byte 19)	0x38	-
Threshold Mask(Byte 20)	0x38	-
Base Unit	0x01	deg. C
Nominal Reading		25
Upper non-recoverable threshold		86
Upper critical threshold		77
Upper non-critical threshold		67
Lower non-recoverable threshold	0x 00	(unspecified)
Lower critical threshold	0x00	(unspecified)
Lower non-critical threshold	0x00	(unspecified)
Sensor Name	temp PCIe switch	-
Rearm mode	0x01	Auto
Hysteresis Support	0x01	Readable
Threshold Access Support	0x01	Readable
Event Message Control	0x00	Per Threshold / Discrete State
Reading Definition	Analog reading byte	Analog sensor reading

## FRU Information and Sensor Data Records

Table 3-16 Hot Swap HDD Sensor

Feature	Raw Value	Description
Sensor LUN	0x00	-
Sensor Number	0x00	-
Entity ID	0xC0	PICMG Rear Transition Module
Sensor Type	0xF0	PICMG 3.0: FRU Hot Swap
Event/Reading Type	0x6F	Discrete (sensor-specific)
Assertion Event Mask(Byte 15)	0x0F	-
Assertion Event Mask(Byte 16)	0x01	-
Deassertion Event Mask(Byte 17)	0x00	-
Deassertion Event Mask(Byte 18)	0x00	-
Threshold Mask(Byte 19)	0x0F	-
Threshold Mask(Byte 20)	0x01	-
Base Unit	0x00	(unspecified)
Sensor Name	Hot Swap HDD	-
Rearm mode	0x01	Auto
Hysteresis Support	0x00	No Hysteresis or unspecified
Threshold Access Support	0x00	No Thresholds
Event Message Control	0x01	Entire Sensor only
Reading Definition	-	Refer chapter "Reading the FRU Hot-Swap Sensor" in the PICMG 3.0 Specification manual



*Table 3-17 RTM Watchdog Sensor*

<b>Feature</b>	<b>Raw Value</b>	<b>Description</b>
Sensor LUN	0x00	-
Sensor Number	0x00	-
Entity ID	0xC0	PICMG Rear Transition Module
Sensor Type	0x23	Watchdog 2
Event/Reading Type	0x6F	Discrete (sensor-specific)
Assertion Event Mask(Byte 15)	0x0F	-
Assertion Event Mask(Byte 16)	0x01	-
Deassertion Event Mask(Byte 17)	0x00	-
Deassertion Event Mask(Byte 18)	0x00	-
Threshold Mask(Byte 19)	0x0F	-
Threshold Mask(Byte 20)	0x01	-
Sensor Name	RTM Watchdog	-
Rearm mode	0x01	Auto
Hysteresis Support	0x00	No Hysteresis
Threshold Access Support	0x00	No Threshold
Event Message Control	0x01	Entire Sensor only
Reading Definition	Analog reading byte	Analog sensor reading



# Related Documentation

---

## A.1 SMART Embedded Computing Documentation

The documentation listed is referenced in this manual. Technical documentation can be found by using the Documentation Search at <https://www.smartembedded.com/ec/support/> or you can obtain electronic copies of SMART EC documentation by contacting your local sales representative.

*Table A-1 SMART EC Documentation*

<b>Document Title</b>	<b>Publication Number</b>
ATCA-7470 Data Sheet	ATCA-7470-DS
ATCA-7475 Data Sheet	ATCA-7475-DS
ATCA-7470 Installation and Use	6806800P15
RTM-ATCA-747x-10G Installation and Use	6806800P15
ATCA-7475 Installation and Use	6806800S38

# Related Documentation

---



