SE1710 SMART Edge Server Video Analytics Platform

Getting Started Guide

P/N: 6806800V33A

August 2020



SMART[™]
Embedded Computing

© 2020 SMART Embedded Computing™, Inc.

All Rights Reserved.

Trademarks

The stylized "S" and "SMART" is a registered trademark of SMART Modular Technologies, Inc. and "SMART Embedded Computing" and the SMART Embedded Computing logo are trademarks of SMART Modular Technologies, Inc. All other names and logos referred to are trade names, trademarks, or registered trademarks of their respective owners. These materials are provided by SMART Embedded Computing as a service to its customers and may be used for informational purposes only.

Disclaimer*

SMART Embedded Computing (SMART EC) assumes no responsibility for errors or omissions in these materials. **These materials are provided "AS IS" without warranty of any kind, either expressed or implied, including but not limited to, the implied warranties of merchantability, fitness for a particular purpose, or non-infringement.** SMART EC further does not warrant the accuracy or completeness of the information, text, graphics, links or other items contained within these materials. SMART EC shall not be liable for any special, indirect, incidental, or consequential damages, including without limitation, lost revenues or lost profits, which may result from the use of these materials. SMART EC may make changes to these materials, or to the products described therein, at any time without notice. SMART EC makes no commitment to update the information contained within these materials.

Electronic versions of this material may be read online, downloaded for personal use, or referenced in another document as a URL to a SMART EC website. The text itself may not be published commercially in print or electronic form, edited, translated, or otherwise altered without the permission of SMART EC.

It is possible that this publication may contain reference to or information about SMART EC products, programming, or services that are not available in your country. Such references or information must not be construed to mean that SMART EC intends to announce such SMART EC products, programming, or services in your country.

Limited and Restricted Rights Legend

If the documentation contained herein is supplied, directly or indirectly, to the U.S. Government, the following notice shall apply unless otherwise agreed to in writing by SMART Embedded Computing.

Use, duplication, or disclosure by the Government is subject to restrictions as set forth in subparagraph (b)(3) of the Rights in Technical Data clause at DFARS 252.227-7013 (Nov. 1995) and of the Rights in Noncommercial Computer Software and Documentation clause at DFARS 252.227-7014 (Jun. 1995).

SMART Embedded Computing, Inc.

2900 S. Diablo Way, Suite 190

Tempe, Arizona 85282

USA

*For full legal terms and conditions, visit www.smartembedded.com/ec/legal

Table of Contents

About this Manual	9
1 Getting Started	13
1.1 Introduction	13
1.2 Audience	13
1.3 Product Overview	13
1.3.1 Features	13
1.3.2 Block Diagram	14
1.3.3 Power Requirements	14
1.3.4 Dimensions and Weight	14
1.3.5 Environmental Conditions	15
1.3.6 Chassis User Interfaces	15
1.3.6.1 Chassis Controls and LEDs	15
1.3.6.2 Front Panel I/O Interfaces	16
1.3.7 Regulatory Compliances	17
1.3.8 Fan Control	17
1.4 Setting up the SE1710	18
1.4.1 What's in the Box	18
1.4.2 Additional Items Required	18
1.4.3 Prepare the Installation Site	18
1.4.4 Mounting Options	19
1.4.5 Installation in a 19" Rack	19
1.4.6 Power Up the System	22
1.4.7 Power Down the System	22
2 Software	25
2.1 Software Introduction	25
2.2 BIOS Settings	25
2.2.1 Default Network Configuration	25
A Related Documentation	27
A.1 SMART Embedded Computing Documentation	27

Table of Contents

List of Tables

Table 1-1	System Power Requirements	14
Table 1-2	Dimensions and Weight of System	14
Table 1-3	Environmental Conditions	15
Table 1-4	LED Descriptions	15
Table 1-5	System Status LED Information	16
Table 1-6	LAN/Port Descriptions	16
Table 1-7	ETH0/ETH1 LEDs	16
Table 1-8	IPMI LAN LEDs	17
Table 1-9	Regulatory Standards	17
Table 2-1	Network Configuration	25
Table A-1	SMART EC Documentation	27

List of Tables

List of Figures

Figure 1-1	SE1710 Block Diagram	14
Figure 1-2	Chassis Controls and LED Locations	15
Figure 1-3	I/O Interface Locations	16
Figure 1-4	SE1710 Mounting Mechanism	20

List of Figures

About this Manual

Overview of Contents

This manual is divided into the following sections.

- [Chapter 1, Getting Started on page 13](#)
- [Chapter 2, Software on page 25](#)



Abbreviations





This document uses the following abbreviations:

Abbreviation	Definition
BMC	Baseboard Management Controller
CPU	Central Processing Unit
DDR	Double Data Rate
DHCP	Dynamic Host Configuration Protocol
ESD	Electro-static Discharge
GPU	Graphics Processing Unit
HDD	Hard Disk Drive
IPMI	Intelligent Platform Management Interface
LAN	Local Area Network
LED	Light Emitting Diode
NVME	Non-volatile Memory Express
PCIe	PCI Express
PSU	Power Supply Unit
RDIMMM	Registered Dual Inline Memory Module
TPE	Twisted Pair Ethernet
UID	Unit Identifier
USB	Universal Serial Bus
VGA	Video Graphics Adapter

Conventions

The following table describes the conventions used throughout this manual.

Notation	Description
0x00000000	Typical notation for hexadecimal numbers (digits are 0 through F), for example used for addresses and offsets
0b0000	Same for binary numbers (digits are 0 and 1)
bold	Used to emphasize a word
Screen	Used for on-screen output and code related elements or commands. Sample of Programming used in a table (9pt)
Courier + Bold	Used to characterize user input and to separate it from system output
<i>Reference</i>	Used for references and for table and figure descriptions
File > Exit	Notation for selecting a submenu
<text>	Notation for variables and keys
[text]	Notation for software buttons to click on the screen and parameter description
...	Repeated item for example node 1, node 2, ..., node 12
.	Omission of information from example/command that is not necessary at the time
..	Ranges, for example: 0..4 means one of the integers 0,1,2,3, and 4 (used in registers)
	Logical OR
	Indicates a hazardous situation which, if not avoided, could result in death or serious injury
	Indicates a hazardous situation which, if not avoided, may result in minor or moderate injury

Notation	Description
	Indicates a property damage message
	Indicates a hot surface that could result in moderate or serious injury
	Indicates an electrical situation that could result in moderate injury or death
<p data-bbox="272 725 386 777">Use ESD protection</p> 	Indicates that when working in an ESD environment care should be taken to use proper ESD practices
	No danger encountered, pay attention to important information

Summary of Changes

This manual has been revised and replaces all prior editions.

Part Number	Publication Date	Description
6806800V33A	August 2020	Early Access version

Getting Started

1.1 Introduction

The SE1710 SMART Edge Server is a 1U server and is referred to in this document as the SE1710. The SE1710 motherboard features the AMD EPYC CPU with DDR4 memory, M.2 storage devices, and three PCI Express (PCIe) GPU cards.

The SE1710 video analytics platform solution for retail applications can process up to eight cameras and provide the ability for retailers to analyze customer trends, buying habits, and other customer information without storing personally identifiable information.

1.2 Audience

SE1710 installers and users

1.3 Product Overview

1.3.1 Features

The main features of the SE1710 SMART Edge Server include:

- AMD EPYC 7282 16-core processor (Rome)
- Up to 2TB DDR4 memory operating at 2400MT/s (Default: 64GB)
- Eight (8) independent DDR4 memory channels with one (1) RDIMM per channel
- Standard EIA-310-D 1U form factor
- Three (3) x16 PCIe single-wide slots for supported add-on cards
- Dual 10Gb Ethernet Controller
- Baseboard Management Controller (BMC) supporting:
 - Two (2) Ethernet links
 - Serial over LAN (SOL) to baseboard
 - KVM (VGA) interface to baseboard

1.3.5 Environmental Conditions

The SE1710 is designed to operate under the following environmental conditions.

Table 1-3 Environmental Conditions

Characteristic	Condition
Storage temperature	-40°C to +70°C
Operating temperature	0°C to 40°C ¹
Humidity range	20% to 90% non-condensing (preliminary)

1. Ambient temperature is defined at the inlet to the SE1710. Some installation locations may have local hot spots that may negatively affect operation.

1.3.6 Chassis User Interfaces

1.3.6.1 Chassis Controls and LEDs

The chassis controls and LED location/functionality is shown in the following figure and tables.

Figure 1-2 Chassis Controls and LED Locations

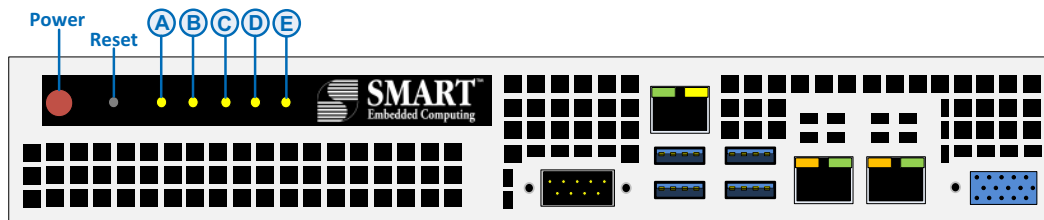

Table 1-4 LED Descriptions

LED	Description
A	Power Indicator
B	HDD Activity
C	ETH0 Activity
D	ETH1 Activity
E	System Status LED

Getting Started

Table 1-5 System Status LED Information

LED Color/Behavior	Description
Solid Red	An overheat condition occurred
Blinking Red (Fast - 1 second)	Fan failure
Blinking Red (Slow - Every 4 seconds)	PSU failure
Solid Blue	Local UID has been activated
Blinking Blue (Very fast - Every 0.3 seconds)	Remote UID is on

1.3.6.2 Front Panel I/O Interfaces

Figure 1-3 I/O Interface Locations

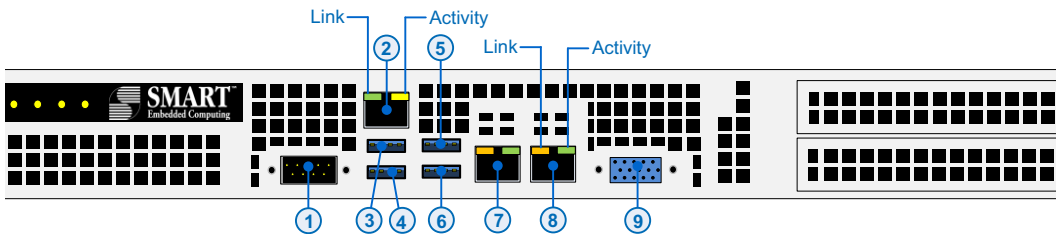

Table 1-6 LAN/Port Descriptions

Port	Description	Port	Description
1	Serial Console DE9 (COM0)	6	USB 3 (3.1)
2	IPMI 10/100/1000 LAN Port (Dedicated BMC)	7	LAN Port ETH0 (Shared by BMC)
3	USB 0 (3.1)	8	LAN Port ETH1
4	USB 1 (3.1)	9	VGA Port
5	USB2 (3.1)		

Table 1-7 ETH0/ETH1 LEDs

LED	Color/Behavior	Description
Link	Off	No link
	Amber	1Gb/s
	Green	10Gb/s
Activity	Flashing Green	Link activity

Table 1-8 IPMI LAN LEDs

LED	Color/Behavior	Description
Link	Off	No link
	Amber	1Gb/s
	Green	10/100Mb/s
Activity	Flashing Yellow	Link activity

1.3.7 Regulatory Compliances

The SE1710 complies with the following regulatory standards:

Table 1-9 Regulatory Standards

Standard	Description
ULCSA 60950-1 EN 60950-1 IEC 60950-1 CB Scheme	Safety requirements
Directive (EU) 2015/863 (amending Annex II to Directive 2011/65/EU)	Directive on the restriction of the use of certain hazardous substances in electrical and electronic equipment (RoHS)
EN 55032 Class A (EU) EN 55024 (EU) ETSI EN 300 386 FCC 47 CFR Part 15 Subpart B (US), Class A	EMC requirements
IEC 62368-1:2014 IEC 62368-1:2018	Audio/Video, Information and Communication Technology Equipment - Safety Requirements
CE	Certified

1.3.8 Fan Control

Fans are autonomous and no direct control is offered or required.

1.4 Setting up the SE1710

1.4.1 What's in the Box

Make sure you receive all items of your shipment:

- One SE1710
- One power cable
- Mounting brackets



When installing or servicing the system or accessories, strictly observe the safety precautions noted in this document. Otherwise, personal injury or property damage may occur. Ignoring these instructions can void the system warranty.

Use ESD protection



Use a properly grounded ESD wrist strap or make sure that you are working in an ESD safe environment.

1.4.2 Additional Items Required

Provide a Twisted Pair Ethernet (TPE) cable for connecting from the LAN1 port on the SE1710 to the upstream network.

1.4.3 Prepare the Installation Site



System is to be installed in a restricted access location by trained personnel according to the installation instructions.

Read all installation instructions in this manual before you install the system.

Basic site planning and installation requirements include the following:

- Make sure that all environmental and power requirements defined are met.
- 600W power should be available for the SE1710 system
- System should be positioned so that a power source is easy to reach
- Sufficient space should be available in racks to install the system

- Suitable equipment should be available to lift the system into the rack
- Cables must be long enough to reach the system
- Make sure the inlet and outlet of the SE1710 is not blocked

1.4.4 Mounting Options

The SE1710 can operate on a table top or it can be installed in a standard 19" rack.

When operating the system on a table top or in a rack, you must allow for 50mm (2 inches) on each side of the server for proper airflow.



During the course of handling, shipping, and assembly, the pins, shrouds and mounting screws, fans and other items can become loose or damaged. Do not operate a damaged shelf, this can cause damage to installed devices.

1.4.5 Installation in a 19" Rack



Stability Hazard

The rack may tip over causing serious personal injury.



Personal or System Damage

Unstable system installation in a rack can cause the rack to tip over.

If your system is the only one in the rack, make sure to mount the system in the lowest part of the rack. If other systems are installed in one rack, start with the heaviest component at the bottom.

If the rack is equipped with stabilizing devices, make sure that they are installed and extended so that the rack is secure. Then proceed to mount or service the system.

Rack configuration may vary. Always refer to the mounting guidelines for the rack that you are using.

The mounting mechanism has three sections per side as shown in [Figure 1-4](#):

- Long bracket
- Short bracket
- Inner section (pre-attached to the SE1710 and does not need to be adjusted)

Getting Started

The short and long brackets connect together and attach to the rack to provide the adjustable element between the vertical rack rails.



The short and long brackets are equipped with aluminum blocks to facilitate installation in the rack (See [Figure 1-4](#)). These aluminum blocks may need to be removed for installation in some rack styles.

Figure 1-4 SE1710 Mounting Mechanism

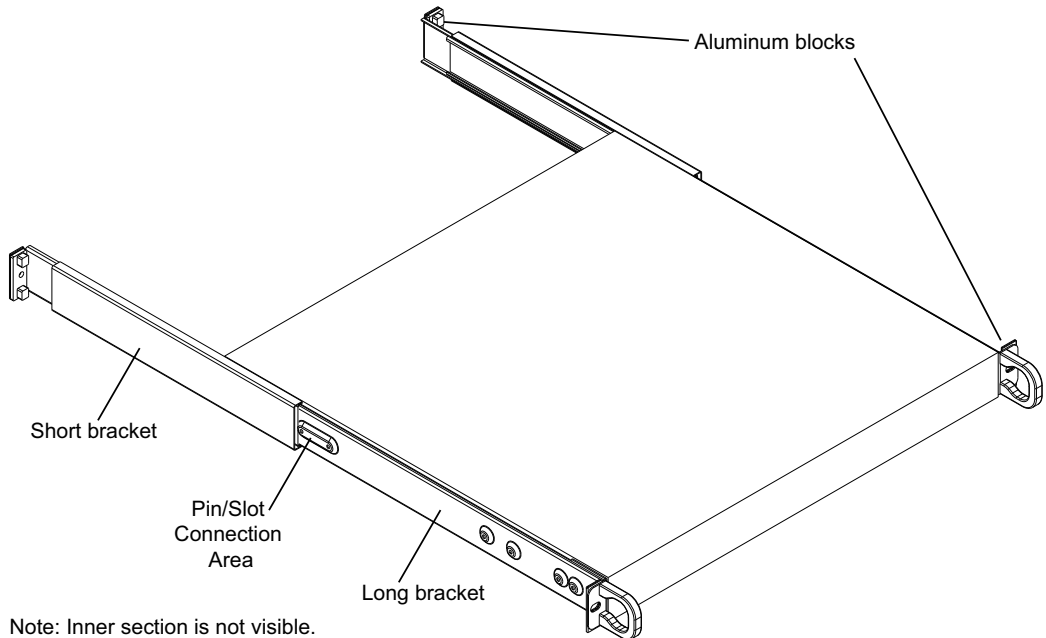

Procedure – Attach Mounting Mechanisms to Rack

1. Determine the height desired for installation in the rack.



Equipment should be inserted into racks from bottom to top to aid in stability.

2. Connect the short and long bracket at the desired length by inserting the pin on one section into the slot from the other section.

Important
Information

The combined assembly should fit snugly between the inside surfaces of the vertical rack mounting rails.

If necessary, the aluminum blocks can be removed from the brackets to accommodate your rack style.

3. Place the bracket assembly in position between the vertical rack mounting rails at the desired height. The short end of the bracket has features to assist in this and should be oriented towards the rear of the rack.
4. Secure this bracket assembly to the vertical rails. Two M5 screws will be needed in the front and three will be needed in the rear.
5. Repeat steps 1-4 on the opposite side of the rack.

Important
Information

When both bracket assemblies are level and secured to the vertical rack rails, they form the slide rails for the chassis to be installed.

Procedure – Install the SE1710 Chassis in the Rack

1. Lift the chassis horizontally. Do not lift with the handles on the front of the server.
2. Align the pre-installed rails on both sides of the chassis with the bracket assemblies that were installed in the rack.
3. Using even pressure, push the chassis completely into the rack.

Important
Information

The pre-installed rails on the sides of the chassis incorporate a locking feature, and it may be necessary to depress the tabs when inserting the system into the rack.

4. Secure the chassis to the rack with the appropriate rack screws.



**Do not put any load or pressure on the chassis during the installation process.
Make sure the chassis is secured in the rack before operation.**

NOTE: The SE1710 can also be placed on a table top.

Getting Started

1.4.6 Power Up the System

Use ESD protection



Use a properly grounded ESD wrist strap or make sure that you are working in an ESD safe environment.

NOTICE

Grounding

The AC PSU, once connected, provides the necessary grounding needed.

Procedure

To power up the system, follow these steps:

1. Connect the power cord to the SE1710 and plug into a power source
2. When AC power is applied, the BMC powers up
3. Press the Power button or login to the BMC to power up the system

Important Information

If AC power was removed while the system was powered up, the BMC will power it up automatically when AC is restored.

Pressing the power button after the system has been powered up triggers a graceful shutdown of the system.

1.4.7 Power Down the System

Use ESD protection



Use a properly grounded ESD wrist strap or make sure that you are working in an ESD safe environment.

Procedure

To power down the system, follow these steps:

1. Login to the BMC
2. Select the Remote Control tab
3. Select Power Control
4. Select Power Off Server - Orderly Shutdown

5. Select Perform Action

This will trigger a graceful shutdown of the server.



Pressing the power button after the system has been powered up also triggers a graceful shutdown of the system.

Software

2.1 Software Introduction

System management and monitoring is accomplished through the BMC and provides a standard IPMI implementation.

2.2 BIOS Settings

The SE1710 requires SR-IOV Support to be enabled in the BIOS. If the BIOS is ever reset to defaults, this functionality will need to be enabled, otherwise the system will fail to boot.

This setting can be found in the BIOS Configuration under: Advanced → PCIe/PCI/PnP Configuration → SR-IOV Support.

2.2.1 Default Network Configuration

A default network configuration is enabled as shown in the following table.

Table 2-1 Network Configuration

Interface	Description	Default IP Address
ETH0	Front panel interface shared by CPU and BMC	Configured to obtain IP address via DHCP for the BMC. The CPU IP address needs to be configured when an OS is installed.
ETH1	Front panel interface for CPU	IP address needs to be configured when an OS is installed.
BMC	Dedicated BMC interface	Configured to obtain IP address via DHCP.

Related Documentation

A.1 SMART Embedded Computing Documentation

The documentation listed is referenced in this manual. Technical documentation can be found by using the Documentation Search at <https://www.smartembedded.com/ec/support/> or you can obtain electronic copies of SMART EC documentation by contacting your local sales representative.

Table A-1 SMART EC Documentation

Document Title	Documentation Number
<i>Video Analytics Brochure</i>	N/A
SE1710 SMART Edge Server Quick Reference	6806800V34
SE1710 SMART Edge Server Safety Notes Summary	6806899V35

Related Documentation

